

Power TIG Series



GeKaMac[®]



PoWer TIG 202 DC PULSE Users Manual

Please Read and Understand This Manual
Before Operating The Welding Machine

www.gedikwelding.com

This machine is for internal use only.

It complies with the WEEE Directive.

This machine has been designed in accordance with the EN 60974-1 and EN 60974-10 standards.

The machine is safe when installation, operation, and maintenance are performed in accordance with the user manual and regulations. The operator and machine owner are responsible for adhering to safety rules.

Gedik Kaynak San. Ve Tic. A.Ş. assumes no responsibility for safety or CE compliance if any modifications are made to the machine or if safety rules are not followed.



This Class A equipment is not suitable for use in homes and similar residential areas where the power supply is provided by the low-voltage public electricity network.



This machine is not household waste and cannot be disposed of in the trash.

When the machine reaches the end of its service life or becomes obsolete, it must be disposed of in accordance with regulations.

COMPLIES WITH THE WEEE DIRECTIVE.

Eco Design Statement

This machine has been designed and manufactured in accordance with the requirements of the 2009/125/EC Eco Design Directive concerning the environmentally friendly design of energy-related products.

Accordingly, machines with an idle mode are as follows.

	Idle Mode
MMA	X
MIG	√
TIG	√
Plazma	√
SAW	Out of Scope

Efficiency measurements should be conducted only on the power unit. The water cooling system should be disabled. For more information on measurements and machine settings, Gedik Kaynak Sanayi ve Ticaret A.Ş. should be consulted.

**AT UYGUNLUK BEYANI****EU DECLARATION OF CONFORMITY**

Bu uygunluk beyanı yalnızca imalatçının sorumluluğu altında düzenlenir.

This declaration of conformity is issued under the sole responsibility of the manufacturer.

İstanbul, Turkey, 08.03.2024

İmalatçı / Manufacturer

GEDİK KAYNAK SANAYİ ve TİCARET A.Ş.

Ankara Cad. No.306 Seyhli Pendik İSTANBUL TÜRKİYE

Ürün / Product

ARC WELDING MACHINE

Marka-Model / Brand- Model

POWER TIG 202 DC PULSE

Yukarıda tanımlanan beyanın nesnesi ilgili uyumlaştırılmış AB mevzuatı ile uyumludur.

The object of the declaration described above, is in conformity with the relevant union harmonisation legislation.

Direktifler / Directives

2014/30/EU & 2014/35/EU & 2009/125/EC
EU/2019/1784

Uyumlaştırılmış standartlar ve uygunluğun deklare edilmesiyle ilişkili diğer referanslar.

References to the relevant harmonised standards used and references to the other technical specifications in relation to which conformity is declared.

EN IEC 60974-1
EN IEC 60974-10

Bu ekipman, talimatlara uygun kurulduğunda, bakımı yapıldığında ve kullanıldığında belirtilen standartlara uygundur. Makine üzerinde bir değişiklik yapıldığında veya yanlış kullanımda deklarasyon geçersiz olur.

The equipment is in compliance with pertinent legislation when installed, utilized, and maintained in accordance with the enclosed instructions. This declaration will be invalid under any modification or improper use.

İmalatçı Adına İmzalayan / Signed for and on behalf of:

Hatice Özel, Equipment Business Unit Director



Introduction	2
Description	2
Features	2
Usage limits (IEC 60974-1)	3
Technical data	3
How to lift up the machine	3
Open the packaging	3
Serial number	3
Installation	3
Connection to the electrical supply	4
Instructions for use	4
TIG welding	4
Electrode welding (MMA)	6
Maintenance	6
Optional	6
The pointing out of any difficulties and their elimination	7
Procedure for welder assembly and disassembly	7
Digital interface PCB replacement	7
Meaning of graphic symbols on machine	8
Wiring diagram	8

Introduction

Thank you for buying our product.

In order to get the best performance out of the plant and ensure the maximum lifespan of its parts, the use and maintenance instructions contained in this manual must be read and strictly complied with, as well as **the safety instructions contained in the relevant folder**. If repairs to the plant are required, we recommend that our clients contact our service centre workshops, as they have the necessary equipment and personnel that are specifically trained and constantly updated.

All our machines and equipment are constantly developed and so changes may be made in terms of their construction and features. For further information on our products or to contact GEKA, go to a GEKA authorized dealer or to GEKA's website at www.gedikwelding.com

Description

POWER TIG 202 DC PULSE with digital control represents the very latest evolution in direct current weld generators with INVERTER technology. This powerful 100 KHz generator, based on the latest generation IGBT, fitted with a planar transformer, makes it possible to TIG weld any metal except for aluminum and its alloys.

POWER TIG 202 DC PULSE also excellent for electrode welding, with its lightness and compactness and first-rate welding characteristics, is ideal for using for maintenance, erection and light steel structural works.

Features

Main features are:

- Innovative and compact design.
- Compact size and light weight for easy transportation.
- Load-bearing structure with panels made of impact-resistant fibre.
- Robust handle integrated into the chassis.
- Control panel protected against accidental impact.
- Sloping front control panel, easy to read and adjust and highly visible from any direction.
- IP 23 S protection class and dust-proof electronic components, thanks to the innovative "Tunnel" fan cooling system, allow their use in the toughest work environments.
- Two control panels are available:
 - **POWER TIG 202 DC PULSE** "basic version" control panel.
 - **POWER TIG 202 DC PULSE** "complete version" control panel.
- Digital control, regulation and monitoring of all welding parameters.
- Digital display for pre-setting welding parameters.
- Digital ammeter is standard fittings, with pre-setting of welding current and saving of the latest value (Hold function).
- Feature that makes it possible to save and call up personalized welding programs (only adjustable with the RW22 control panel).
- Self-diagnosis device.
- Overheating thermostatic protection.
- Automatic compensation for mains voltage fluctuations within $\pm 20\%$.
- Safety barrier against excess voltage from mains.
- Electromagnetic disturbance is reduced due to high frequency being involved only during the arc ignition phase.
- "Energy Saving" function that starts ventilation of the generator only when necessary.
- This generator also conforms to all the standards and directives in force in the European Community.
- **TIG**
 - Excellent TIG welding characteristics.
 - High frequency arc striking of TIG welding, precise and efficient even from long distance.
 - Using special TIG torches allows remote adjustment of welding current directly from the torch.
 - Standard built-in pulsation with provision for entering the SYN Pulse function (only adjustable with the GEKA control panel).

• **MMA**

- The VRD (Voltage Reduction Device) can be activated, which reduces voltages to below 12 V, which means that the welding machine can be used in ambient conditions in which there is a high electrical risk, thereby providing maximum operator safety.
- Arc Force to select the best dynamic characteristics of the welding arc (only adjustable with the POWER TIG 202 DC PULSE control panel).
- Hot Start to improve ignition with particularly difficult electrodes (only adjustable with the POWER TIG 202 DC PULSE control panel).
- Anti-sticking function to avoid the electrodes sticking.

Usage limits (IEC 60974-1)

The use of a welder is typically discontinuous, in that it is made up of effective work periods (welding) and rest periods (for the positioning of parts, the replacement of wire and under flushing operations etc. This welder is dimensioned to supply a I_2 max nominal current in complete safety for a period of work of X% of the total usage time. The regulations in force establish the total usage time to be 10 minutes. The work cycle is considered to be X% of this period of time. If the permitted work cycle time is exceeded, an overheat cut-off occurs to protect the components around the welder from dangerous overheating. Activation of thermal protection is signaled by "t° C" flashing on control panel display (for further information see the POWER TIG 202 DC PULSE control panel manual). After several minutes the overheat cut-off rearms automatically and the welder is ready for use again.

Technical data

The general technical data of the system are summarized in table 1.

How to lift up the machine

The weld machine has a strong handle all in one with the frame, used for transporting the machine manually only.

NOTE: These hoisting and transportation devices conform to European standards. Do not use other hoisting and transportation systems.

Open the packaging

Upon receiving the system:

- Remove the welding generator and all relevant accessories-components from their packaging.
- Check that the weld machine is in good condition, if not report any problems immediately to the seller-distributor.
- Make sure all ventilation grilles are open and that no foreign bodies are blocking the air circulation.

Serial number

The welding machine's serial number is shown on the unit's data plate.

The serial number provides the key to tracing the production lot applicable to the product. The serial number may be essential with ordering spare parts or planning maintenance.

Installation

The installation site for the system must be carefully chosen in order to ensure its satisfactory and safe use. The user is responsible for the installation and use of the system in accordance with the producer's instructions contained in this manual. Before installing the system the user must take into consideration the potential electromagnetic problems in the work area. In particular, we suggest that you should avoid installing the system close to:

- Signaling, control and telephone cables.
- Radio and television transmitters and receivers.
- Computers and control and measurement instruments.
- Security and protection instruments.

Table 1

Model	POWER TIG 202 DC PULSE	
	TIG DC	MMA
Single-phase power supply 50/60 Hz	V	1~230 ±20%
Mains supply: Z_{max} (*)	Ω	0,19
Power input @ I_2 Max	kVA	8,5 9,0
Delayed fuse (I_2 @ 100%)	A	20
Power factor / $\cos\phi$		0,67 / 0,99
Maximum efficiency degree	η	0,82 0,84
Open circuit voltage	V	88
Current range	A	5÷200 5÷160
Duty cycle @ 100% (40°C)	A	120 110
Duty cycle @ 60% (40°C)	A	140 130
Duty cycle @ X% (40°C)	A	200 (25%) 160 (30%)
Standards	IEC 60974-1 • IEC 60974-3 • IEC 60974-10 	
Insulation class	IP 23 S	
Protection class	F	
Dimensions	mm	390-300-135
Weight	kg	7,5



(*) Main's supply Z_{max} : maximum impedance value allowed for the grid according to the EN/IEC 61000-3-11 standard.

WARNING: This equipment does not comply with EN/IEC 61000-3-12. If it is connected to a public low voltage system, it is the responsibility of the installer or user of the equipment to ensure, by consultation with the distribution network operator, if necessary, that the equipment may be connected.

Table 2

Model	POWER TIG 202 DC PULSE		
		TIG DC	MMA
Power input @ I ₂ Max	kVA	8,5	9,0
Delayed fuse (I ₂ @ 100%)	A	20	
Duty cycle @ X% (40°C)	A	200 (25%)*	160 (30%)*
Supply connection cable			
Length	m	2,5	
Section	mm ²	2,5	
Earth cable			
Section	mm ²	25	

* Factor of efficiency

Persons fitted with pace-makers, hearing aids and similar equipment must consult their doctor before going near a machine in operation. The environment in which the equipment is installed must be suitable for the casing's protection level. This system is cooled by means of the forced circulation of air and must therefore be placed in such a way that the air may be easily sucked in and expelled through the apertures made in the frame.

The welding unit is characterised by the following levels:

- Protection level IP 23 S indicates that the equipment can be used both indoors and outdoors.
- Use class II means that the equipment can be used in conditions subject to heightened electrical shock.

Connection to the electrical supply

Before connecting the welder to the electrical supply, check that the machine's plate rating corresponds to the supply voltage and frequency and that the line switch of the welder is in the "O" position.

Connection to the power supply must be carried out using the tripolar cable supplied with the system, of which:

- 2 conducting wires are needed for connecting the machine to the supply.

Connect a suitable load of normalised plug (2P + e) to the power cable and provide for an electrical socket complete with fuses or an automatic switch. The earth terminal must be connected to the earth conducting wire of the supply.

Table 2 shows the recommended load values for retardant supply fuses.

NOTE 1: Any extensions to the power cable must be of a suitable diameter, and absolutely not of a smaller diameter than the special cable supplied with the machine.

NOTE 2: It is not advisable to plug up the welder to motor-driven generators, as they are known to supply an unstable voltage.

Instructions for use

COMMAND AND CONTROL UNITS (Fig. A)

- Pos. 1 POWER TIG 202 DC PULSE command and control panel
 Pos. 2 Positive pole quick connection.
 Pos. 3 Fast coupling TIG torch gas tube.
 Pos. 4 TIG weld auxiliary control connector (torch button, remote control pedal, etc.).
 Pos. 5 Negative pole quick connection.
 Pos. 6 Power supply switch.
 In the "O" position the welder is off.
 Pos. 7 Mains cable.
 Pos. 8 Weld gas inlet coupling.

TIG welding

In the TIG process welding is achieved by melting the two metal pieces to be joined, with the possible addition of material from the outside, using an arc ignited by a tungsten electrode. The molten bath and the electrode are protected by and inert gas (e.g., Argon, and a flow rate of around 8-14 litres per minute). If necessary, to complete the welded joint, suitable additional material is added.



The type of additional material and welding current are determined according to the type of thickness of the base material, the shape of the joint, and the position of the weld.

- 1) Connecting the welding cables (Fig. B):
 - Connect the gas hose to the Argon cylinder.
 - With the machine switched off:
 - Connect the ground cable to the snap-on connector marked + (positive).
 - Connect the relative ground clamp to the workpiece or to the workpiece support in an area free of rust, paint, grease, etc..
 - Connect the TIG torch power cable to the snap-on connector marked - (negative).
 - Connect the torch gas tube to the connection (Pos. 3, Fig. A).
 - Insert the torch button connector in the 6 poles holder (Pos. 4, Fig. A).
- 2) Switch the welding machine on by moving the power supply switch to I (Pos. 6, Fig. A).
- 3) Make the adjustments and select the parameters on the control panel (for further information see the POWER TIG 202 DC PULSE con-trol panel manual).

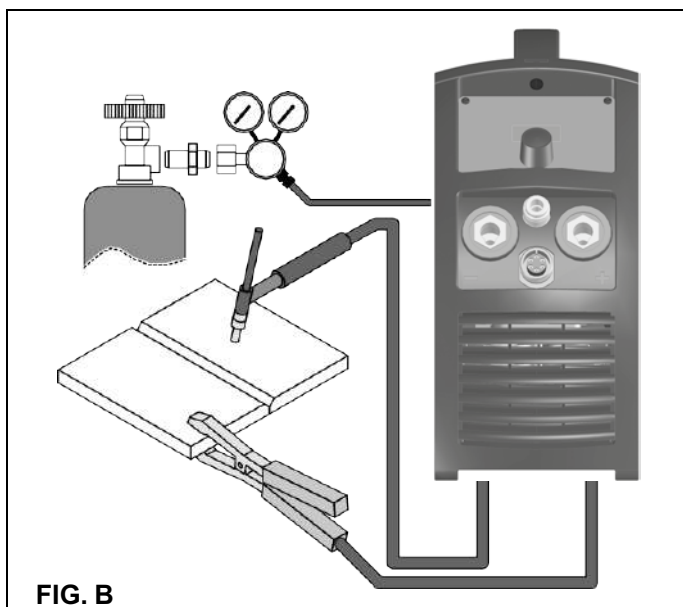

FIG. B

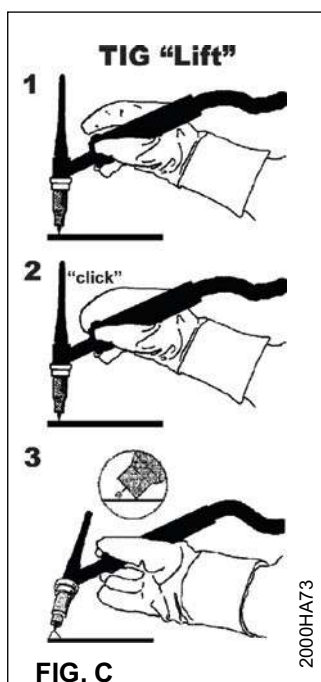

FIG. C

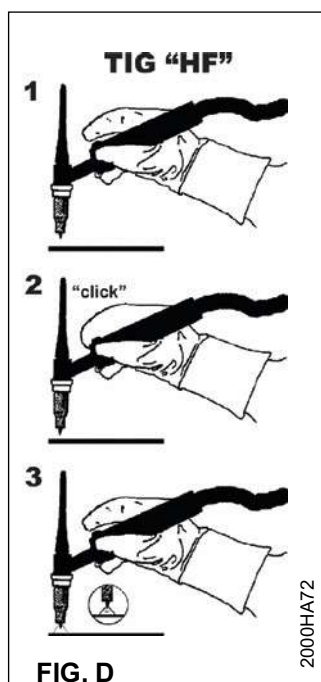

FIG. D

TIG WELDING WITH "Lift" TYPE STRIKING

- 4a) Open the gas cylinder and flow regulator (8-14 l/min).
 - 5a) Put the electrode at the point at which welding is to begin, put the TIG torch at an angle so that the edge of the gas nozzle is not on top of the piece to be welded, keeping contact between the point of the electrode and the piece to be welded (Fig. C-1).
 - 6a) Press the torch button.
 - 7a) The "Lift" function strikes the arc when the TIG torch electrode comes into contact with the workpiece and is then removed (Fig. C-2)
 - 8a) Carry out TIG welding (Fig. C-3).
- To end welding:
- Lift the torch slowly, at a certain point the welding current decreases, and then stop.
 - The welding machine follows an automatic down slope along with extinguishing of the arc.
- 9a) When finished welding remember to shut off the gas cylinder.

TIG WELDING WITH HIGH FREQUENCY STRIKING (HF)

- 4b) Open the gas cylinder and flow regulator (8-14 l/min).
- 5b) Put the electrode at the point at which welding is to begin, put the TIG torch at an angle so that the edge of the gas nozzle is not on top of the piece to be welded, keeping a 2-3 mm gap between the point of the electrode and the piece to be welded (Fig. D-1).
- 6b) Press the torch button.
- 7b) The voltaic arc strikes even without contact between the TIG torch electrode and the workpiece (Fig. D-2).
- 8b) To continue welding put the torch back in its normal position (Fig. D-3).
- 9b) When finished welding remember to shut off the gas cylinder.

IMPORTANT: The high frequency switches off automatically after switching on.

PART TO BE WELDED

The part to be welded must always be connected to ground in order to reduce electromagnetic emission. Much attention must be afforded so that the ground connection of the part to be welded does not increase the risk of accident to the user or the risk of damage to other electric equipment. When it is necessary to connect the part to be welded to ground, you should make a direct connection between the part and the ground shaft. In those countries in which such a connection is not allowed, connect the part to be welded to ground using suitable capacitors, in compliance with the national regulations.

WELDING PARAMETERS

Table 3 shows the currents to use with the respective electrodes for TIG welding. This input is not absolute but is for your guidance only; read the electrode manufacturers' instructions for a specific choice. The diameter of the electrode to use is directly proportional to the current being used for welding.

Table 3

Ø ELECTRODE (mm)	CURRENT (A)
1,2	10 ÷ 80
1,6	70 ÷ 150
2,4	140 ÷ 250
3,2	225 ÷ 400
4,0	300 ÷ 500

Before use, sharpen the tungsten electrode, forming a tip about 1,5 times its diameter.

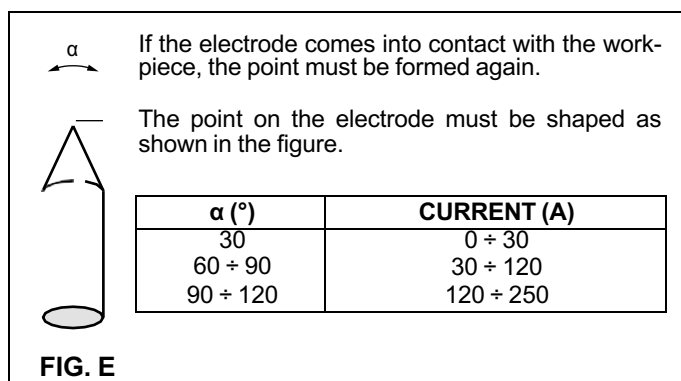

FIG. E

Electrode welding (MMA)

The welding electrode is used to weld most metals (various types steel, etc.), for which rutile and basic electrodes are used.

1) Connecting the welding cables (Fig. F):

Disconnect the machine from the mains power supply and connect the welding cables to the output terminals (Positive and Negative) of the welding machine, attaching them to the clamp and ground with the polarity specified for the type of electrode being used (Fig. F). Always follow the electrode manufacturer's instructions. The welding cables must be as short as possible, they must be near to one another, positioned at or near floor level. Do not touch the electrode clamp and the ground clamp simultaneously.

2) Switch the welding machine on by moving the power supply switch to I (Pos. 6, Fig. A).

3) Make the adjustments and select the parameters on the control panel (for further information see the POWER TIG 202 DC PULSE control panel manual).

4) Carry out welding by moving the torch to the workpiece. Strike the arc (press the electrode quickly against the metal and then lift it) to melt the electrode, the coating of which forms a protective residue. Then continue welding by moving the electrode from left to right, inclining it by about 60° compared with the metal in relation to the direction of welding.

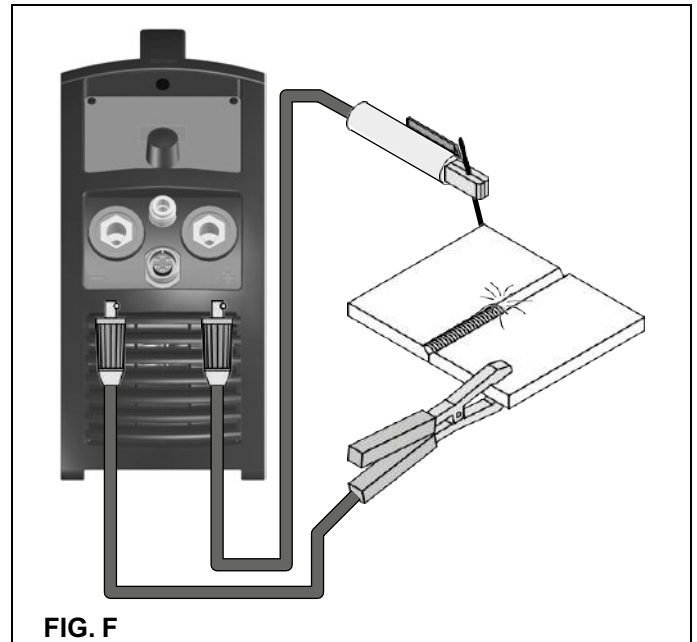

FIG. F

PART TO BE WELDED

The part to be welded must always be connected to ground in order to reduce electromagnetic emission. Much attention must be afforded so that the ground connection of the part to be welded does not increase the risk of accident to the user or the risk of damage to other electric equipment. When it is necessary to connect the part to be welded to ground, you should make a direct connection between the part and the ground shaft. In those countries in which such a connection is not allowed, connect the part to be welded to ground using suitable capacitors, in compliance with the national regulations.

WELDING PARAMETERS

Table 4 shows some general indications for the choice of electrode, based on the thickness of the parts to be welded. The values of current to use are shown in table 5 with the respective electrodes for the welding of common steels and low-grade alloys. These data have no absolute value and are indicative data only. For a precise choice follow the instructions provided by the electrode manufacturer.

Table 4

WELDING THICKNESS (mm)	Ø ELECTRODE (mm)
1,5 ÷ 3	2
3 ÷ 5	2,5
5 ÷ 12	3,2
≥ 12	4

Table 5

Ø ELECTRODE (mm)	CURRENT (A)
1,6	30 ÷ 60
2	40 ÷ 75
2,5	60 ÷ 110
3,2	95 ÷ 140
4	140 ÷ 190

The current to be used depends on the welding positions and the type of joint, and it increases according to the thickness and dimensions of the part.

The current intensity to be used for the different types of welding, within the field of regulation shown in table 5 is:

- High for plane, frontal plane and vertical upwards welding.
- Medium for overhead welding.
- Low for vertical downwards welding and for joining small pre-heated pieces.

A fairly approximate indication of the average current to use in the welding of electrodes for ordinary steel is given by the following formula:

$$I = 50 \times (\text{Øe} - 1)$$

Where:

I = intensity of the welding current

Øe = electrode diameter

Example:

For electrode diameter 4 mm

$$I = 50 \times (4 - 1) = 50 \times 3 = 150A$$

Maintenance

ATTENTION: Before carrying out any inspection of the inside of the generator, disconnect the system from the supply.

SPARE PARTS

Original spare parts have been specially designed for our equipment. The use of non-original spare parts may cause variations in performance or reduce the foreseen level of safety. We decline all responsibility for the use of non-original spare parts.

GENERATOR

As these systems are completely static, proceed as follow:

- Periodic removal of accumulated dirt and dust from the inside of the generator, using compressed air. Do not aim the air jet directly onto the electrical components, in order to avoid damaging them.
- Make periodical inspections in order to individuate worn cables or loose connections that are the cause of overheating.

Optional

POWER TIG 202 DC PULSE generators can be fitted with various remote control devices and accessories.

The remote controls can be only used in the 2-STROKE and 4-STROKE welding modes.

MANUAL REMOTE CONTROL CD6

WARNING:

Weld current can be measured at a distance by connecting up this control. The display will show the previous maximum weld current value set on the welder. The remote control will adjust welding current from the minimum to this value (for further information see the POWER TIG 202 DC PULSE control panel manual). Just turn the adjustment knob on the welder to change the maximum output value.

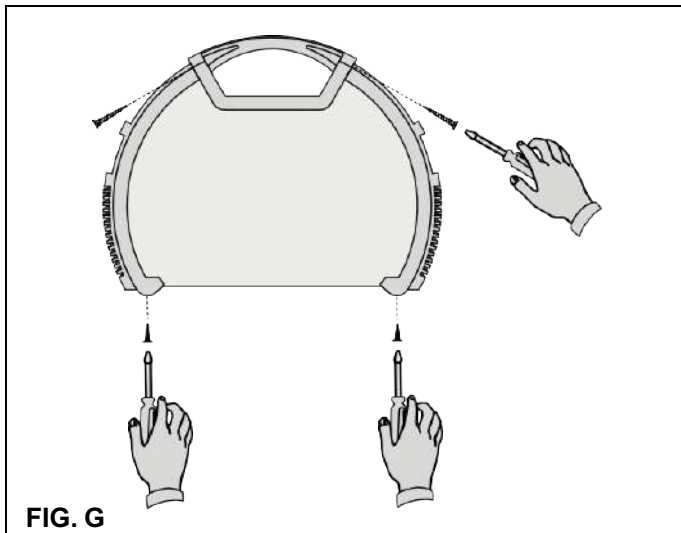

Procedure for welder assembly and disassembly

Proceed as follows (Fig. G):

- Unscrew the 4 screws holding the front and back panels.
- Unscrew the 2 screws holding the handle.
- Proceed the other way round to re-assemble the welder.

Digital interface PCB replacement

Proceed as follows:

- Unscrew the 4 screws fastening the front rack panel.
- Remove the adjustment knob.
- Extract wiring connectors from digital interface PCB.
- Remove digital interface PCB by lifting it out of its supports.
- Proceed vice versa to assemble new digital interface PCB.

FOOT SWITCH PSR7

The foot switch replaces the torch button and the welding current setting knob. The display will show the previous maximum weld current value set on the welder. The pedal will adjust the welding current from the minimum to this value (for further information see the *POWER TIG 202 DC PULSE* control panel manual). Just turn the adjustment knob on the welder to change the maximum output value.

NOTE:

- To use the pedal control correctly, set the "welding mode" to 2-STROKE and then the welding parameters SLOPE UP time to 0 sec., SLOPE DOWN time to 0 sec.
- When using the machine for TIG welding the operator can use the torch button to start the weld and the pedal to regulate the welding current remotely.

AIR AND/OR WATER-COOLED TORCH UP/ DOWN

The up/down torch replaces the current setting knob on the front of the welder. Press right (+) and left (-) button to adjust the active parameter. With this kind of torch, it is also possible to scroll the saved programmes by pressing the two (+) and (-) buttons.

NOTE: The value shown on the display during welding represents the effective current output with all types of control.

The digital control unit of the generator is fitted with a control recognition device which allows it to identify which device is connected and take action accordingly. To allow the command recognition device to work correctly, connect (with the machine switched off) the required accessory to the relative connector and then switch on the welding machine with the on/off switch.

NOTE: It is not possible to memorize or open programmes when the remote controls are connected (except for the torch with UP/DOWN commands).

When the machine is doing a programmed weld, if a remote control command is activated (and the self-recognition procedure is carried out), it exits programming automatically.







The pointing out of any difficulties and their elimination







The supply line is attributed with the cause of the most common difficulties. In the case of breakdown, proceed as follows:

- 1) Check the value of the supply voltage
- 2) Check that the power cable is perfectly connected to the plug and the supply switch
- 3) Check that the power fuses are not burned out or loose
- 4) Check whether the following are defective:
 - The switch that supplies the machine.
 - The plug socket in the wall.
 - The generator switch.

NOTE: Given the required technical skills necessary for the repair of the generator, in case of breakdown we advise you to contact skilled personnel or our technical service department.

Meaning of graphic symbols on machine

	Power supply switch
	System for use in environments with increased risk of electroshock
	Product suitable for free circulation in the European Community
	Danger! High voltage
	Grounding
	Positive pole snap-in connector
	Negative pole snap-in connector

	Connector for the remote control
	Warning!
	Fast coupling TIG torch gas tube
	Before using the equipment, you should carefully read the instructions included in this manual
	MMA welding
	TIG welding
	Special disposal

Wiring diagram

•1 C11-12-13-24	•2 CD 6	•3 CT	•4 D1-2	•5 D8-12	•6 DD	•7 DW	•8 ED	•9 EVG	
•10 FPP	•11 FPS	•12 IL	•13 MV	•14 PD	•15 PSR 7	•16 PT	•17 Q1-2-3-4	•18 RF	•19 SF
•20 SHF	•21 S-INT DIG	•22 S-INV	•23 SS	•24 THS	•25 THF	•26 TORCH	•27 TORCH UP/DOWN		
•28 TP	•29 UP								

Key to the electrical diagram

•1 Capacitors •2 Remote control •3 TIG torch connector •4 Secondary diode
 •5 Primary circuit rectifier •6 Digital display •7 DOWN button •8 Encoder •9
 Gas solenoid valve •10 Pedal control potentiometer •11 Microswitch •12
 Main's switch •13 Fan •14 Remote current potentiometer •15 Pedal control
 •16 TIG torch button •17 Primary IGBT circuit •18 Membrane keyboard
 •19 EMC filter PCB •20 High frequency (HF) PCB •21 Digital interface PCB
 •22 Primary Inverter PCB •23 Secondary circuit PCB •24 Secondary circuit
 thermostat •25 HF transformer •26 TIG torch •27 Up / Down TIG torch •28
 Main transformer •29 UP button

Colour key

Ar Orange
Az Sky Blue
Bc White
Bl Blue
Gg Grey
Gl Yellow
GV Yellow Green
Mr Brown
Nr Black
Ro Pink
Rs Red
Vd Green
VI Violet

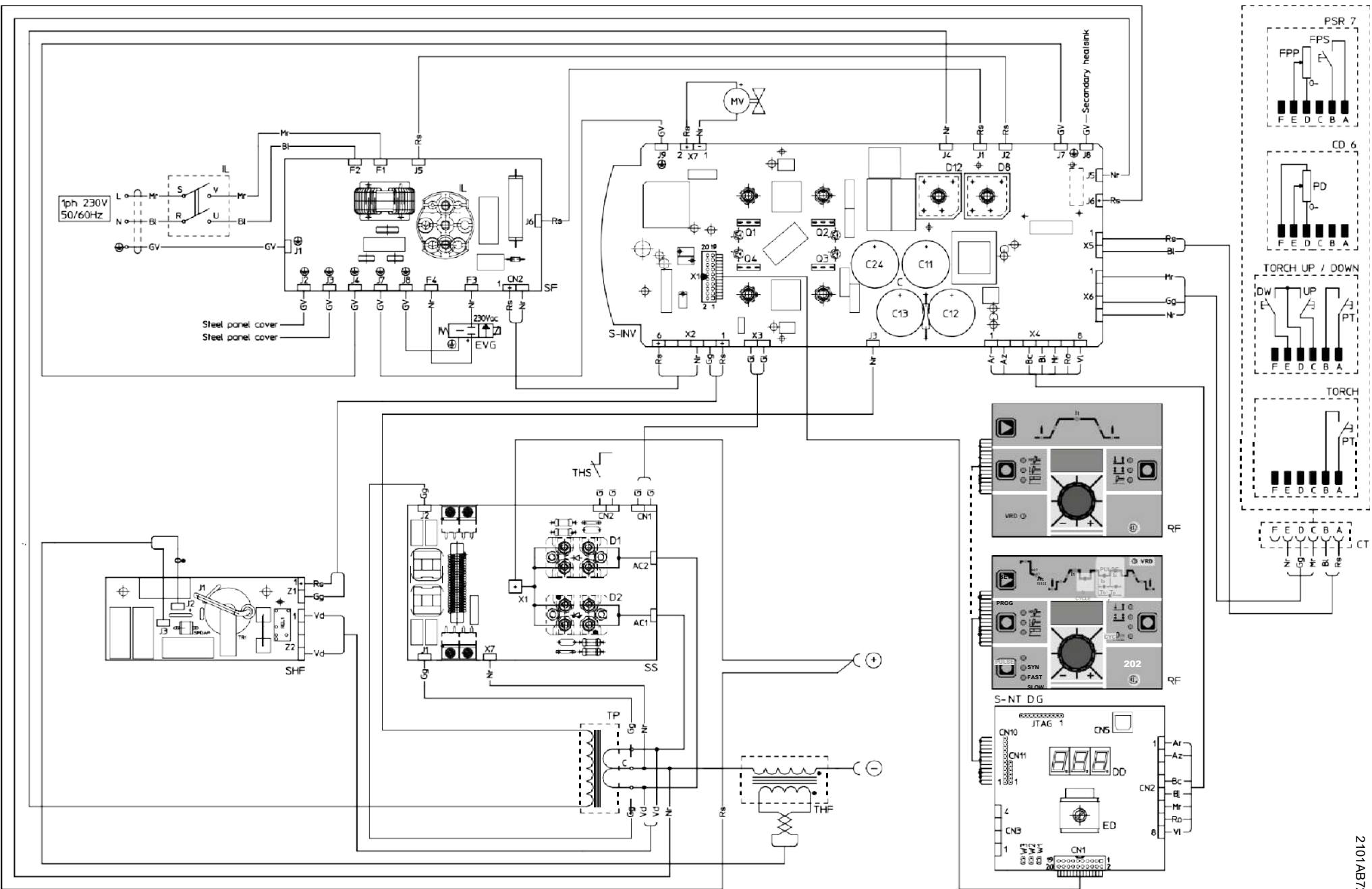

Power TIG Series



GeKaMac®



PoWer TIG 202 DC PULSE Users Manual

Please Read and Understand This Manual
Before Operating The Welding Machine

www.gedikwelding.com

EN Spare parts list

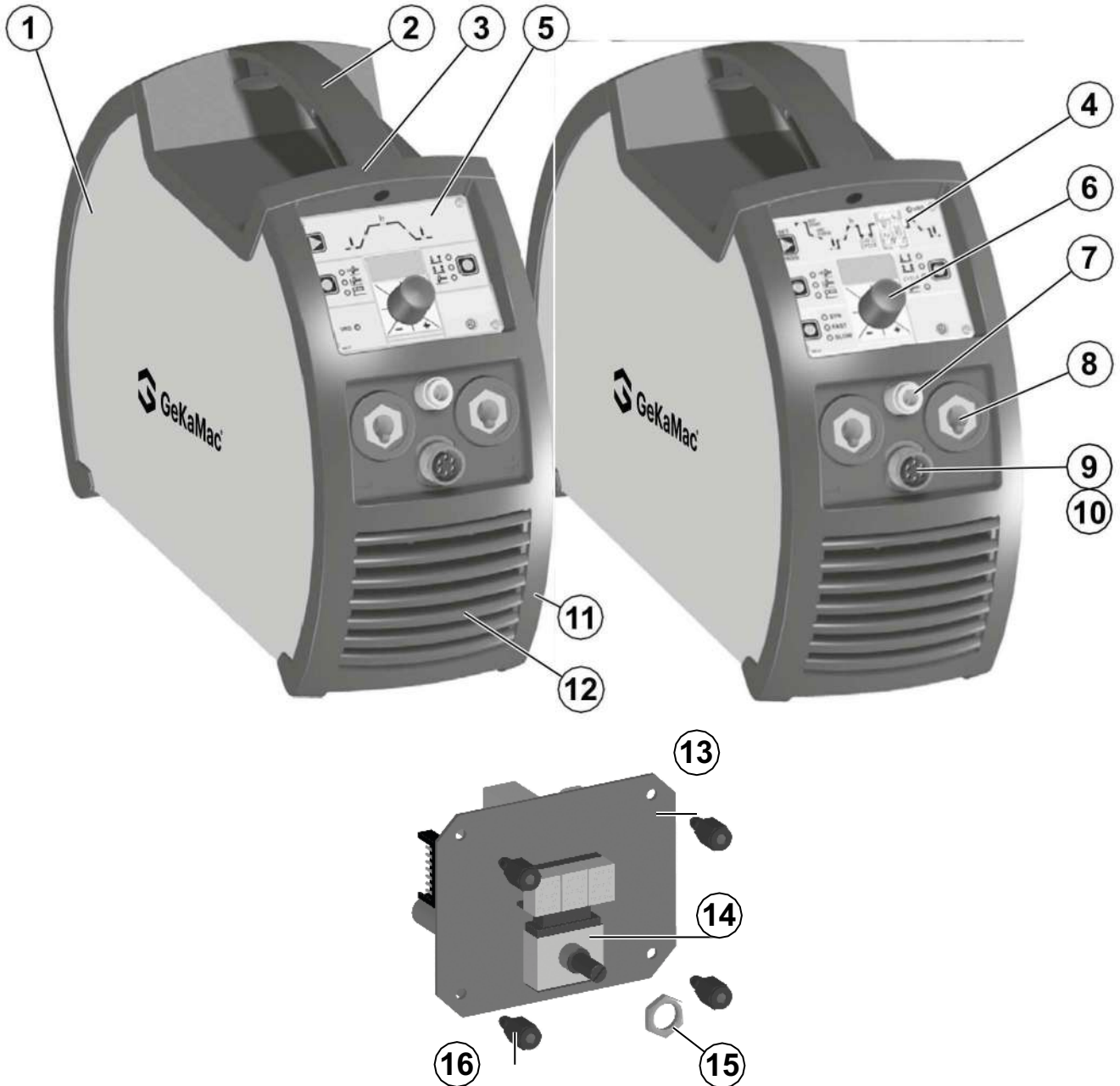

Pos.	POWER TIG 202 PULSE	Description
1	352551	Side panel
2	438205	Handle
3	365850	Shoulder bag connection
4	447865	Membrane keyboard POWER TIG 202 PULSE
	-	Membrane keyboard POWER TIG 202 PULSE
5	-	Membrane keyboard POWER TIG 202 PULSE
6	438849	Encoder adjustment knob
7	403635	Gas quick connection
8	403611	Quick connection
9	419002	6 poles torch connector
10	423134	Torch connector nut
11	352464	Front panel
12	352384	Ventilation grill
13	-	Rack pcb POWER TIG 202 PULSE
	-	Rack pcb POWER TIG 202 PULSE
	377173A	Rack pcb POWER TIG 202 PULSE
14	454150	Encoder
15	423102	Encoder nut
16	424027	Rack pcb spacer

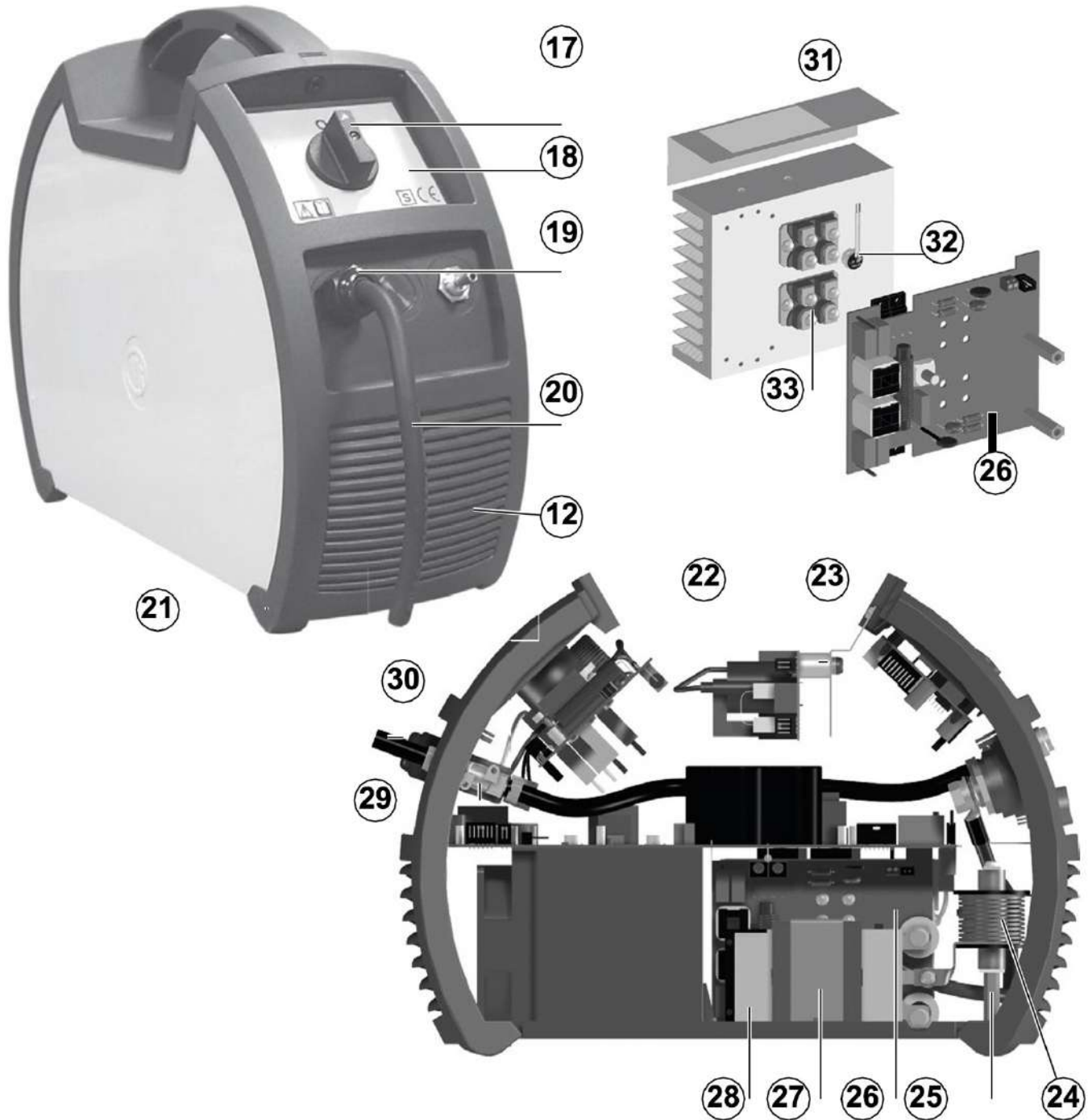

Pos.	POWER TIG 202 PULSE	Description
17	438710	Switch knob
18	467025	Rear panel sticker
19	427895	Main cable clamp
20	235996	Main cable
21	352383	Rear panel
22	377230	Spark gap pcb
23	424009	Spark gap pcb spacer
24	239984	HF transformer
25	424159	HF transformer spacer
26	377175	Secondary pcb
27	463220	Transformer clamp
28	481420	Main transformer
29	425933	Gas solenoid valve
30	485040	Gas hose
31	466900	Heatsink insulation
32	478786	Thermostat
33	423236	Secondary diode

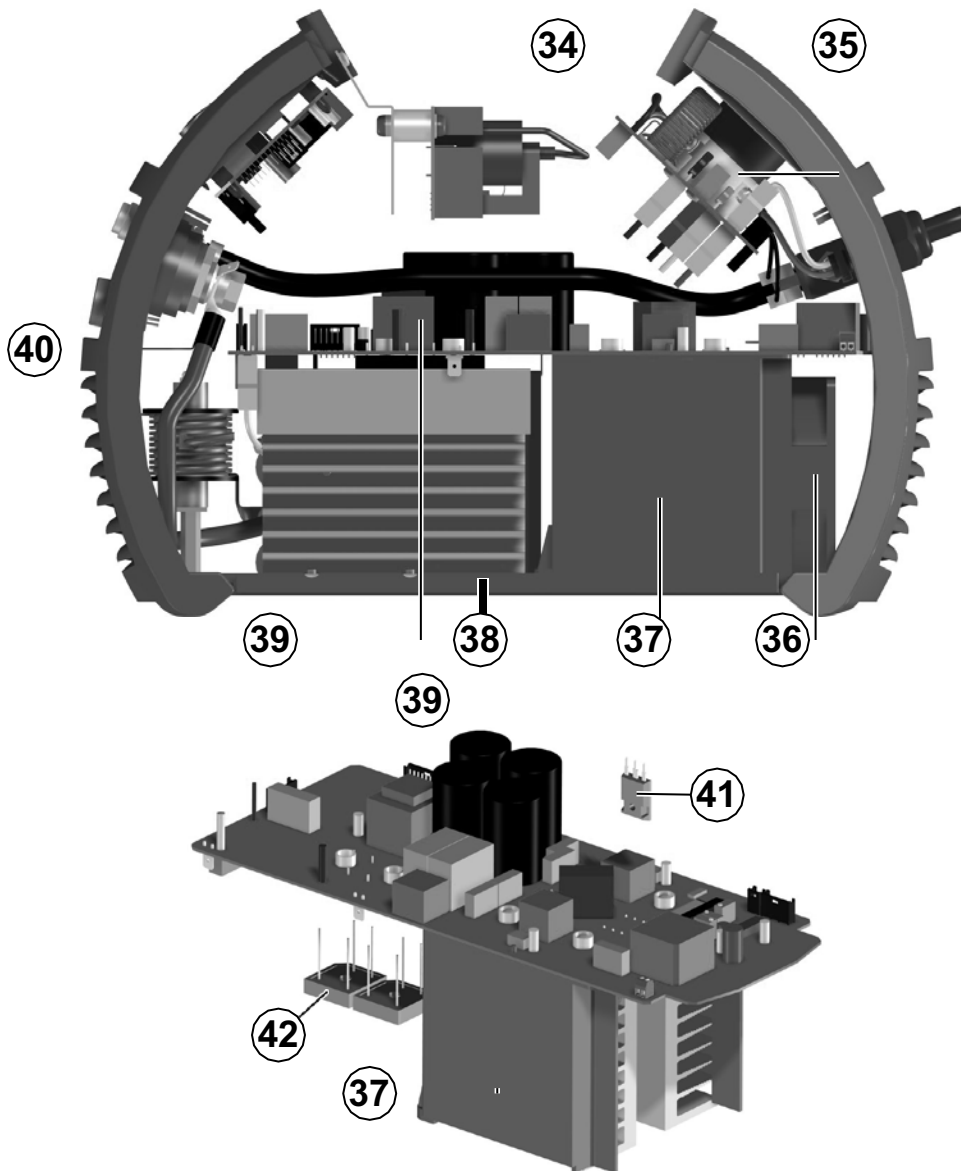

Pos.	POWER TIG 202 PULSE	Description
34	377174	Power supply / EMC pcb
35	435375	Main switch
36	444510	Fan
37	427251	Plastic primary heatsink clamp
38	352475	Plastic base
39	240492	Power inverter assembly
40	413396	Electric auxiliary wiring
41	286020	Primary IGBT
42	455510	Primary rectifier

EN Ordering spare parts

To ask for spare parts clearly state:

- 1) The code number of the piece
- 2) The name of the machine
- 3) The voltage and frequency read on the rating plate
- 4) The serial number of the machine

EXAMPLE

N. 2 pieces code n. 423236 - for POWER TIG 202 PULSE - 230 V -
50/60 Hz - Serial number

POWER TIG

EN

Operator's manual

READ CAREFULLY

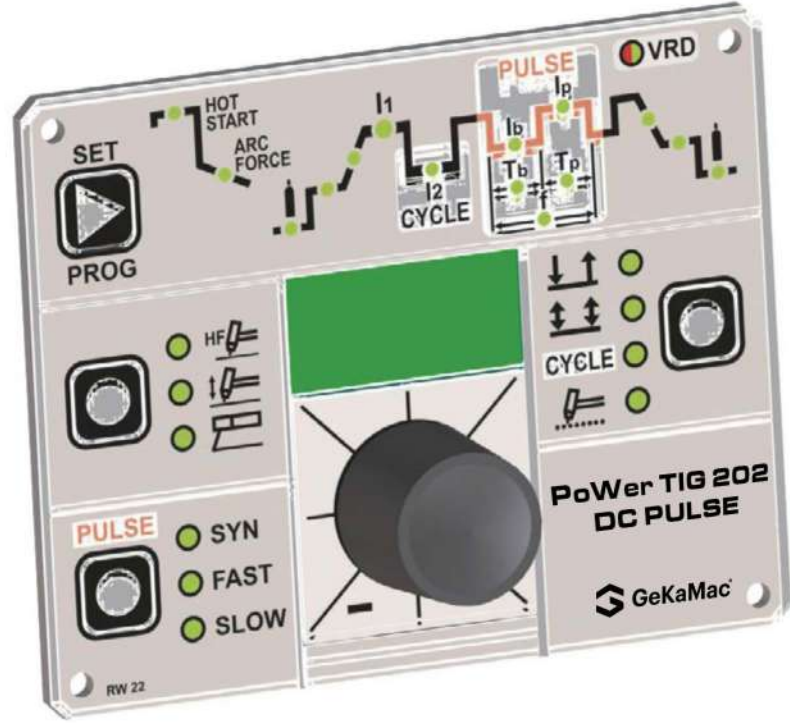

 **GeKaMac®**

Gedik Welding Inc.

Ankara Caddesi No: 306 Şeyhli 34906 Pendik - İstanbul / Turkey

P. +90 216 378 50 00 • F. +90 216 378 20 44

www.gedikwelding.com

Introduction	2
Control panel	2
Displaying the software version installed	4
Electrode welding (MMA)	4
TIG welding	4
TIG welding with the SPOT WELDING function on	5
TIG welding - Welding parameters	5
Creating and memorising automatic welding points	8
PROGRAMMED and/or MANUAL welding	8
Calling up saved programs	9
Viewing the parameters set	9
Activating the VRD device	9
Auxiliary functions	10
Factory default	10
Error and protection conditions	10

Introduction

This manual describes the functions on and how to use the following control panels:

- **POWER TIG 202 PULSE**

Control panel

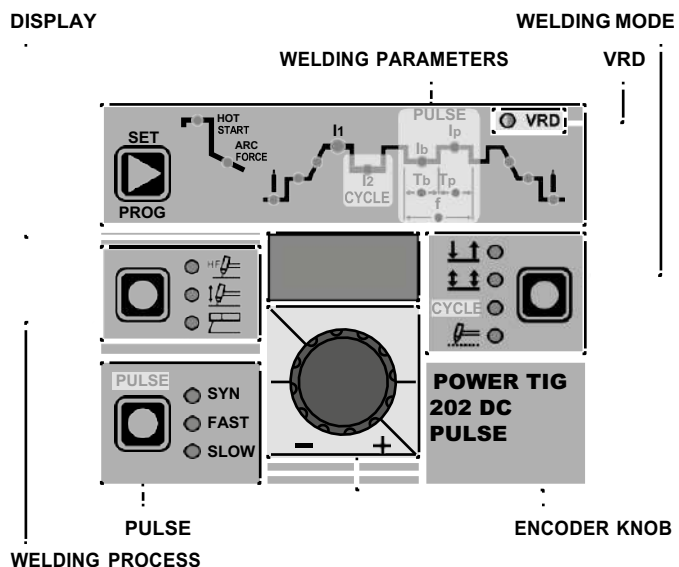

■ ENCODER KNOB

This is used to regulate and change the welding parameters, according to which LED is switched on and the value shown on the DISPLAY, which is necessary for the machine to work correctly.

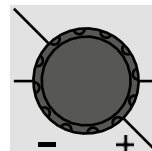

■ DISPLAY

Displays the selections made using the various keys (with corresponding LED on or flashing) and regulated using the ENCODER knob.

■ VRD

The Voltage Reduction Device (VRD) is a safety device that reduces the voltage. It prevents voltages forming on the output terminals that may pose a danger to people.

Two-tone LED (off - red - green) indicates enabling of the VRD device.

The standard, preset settings for the firm do not activate the VRD function on the welding machine and so this LED is normally off. To activate the VRD device, see the relevant paragraph.

WELDING PROCESS

The welding machine offers 3 TIG/Electrode welding processes. Each time the button is pushed, the welding machine switches to select the welding process indicated by the LED that stays lit, in the following order:

- L1** TIG with HF ignition
- L2** TIG with "Lift" type ignition
- L3** ELECTRODE (MMA)

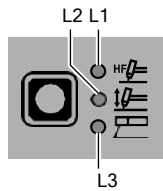

WELDING MODE

The welding machine offers 4 welding modes. Each time the button is pushed, the welding machine switches to select the welding mode indicated by the LED that stays lit, in the following order:

- L4** 2 STROKES
- L5** 4 STROKES
- L6** CYCLE
- L7** SPOT WELDING

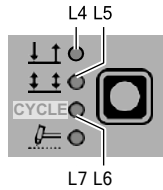

L4 2 STROKES

TIG welding takes place as follows:

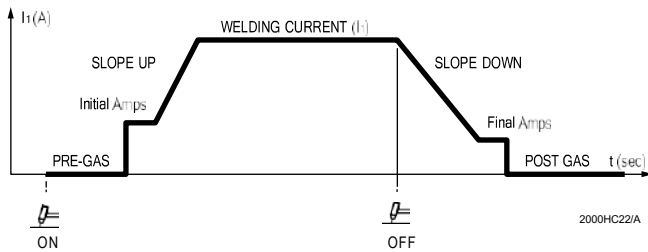

L5 4 STROKES

TIG welding takes place as follows:

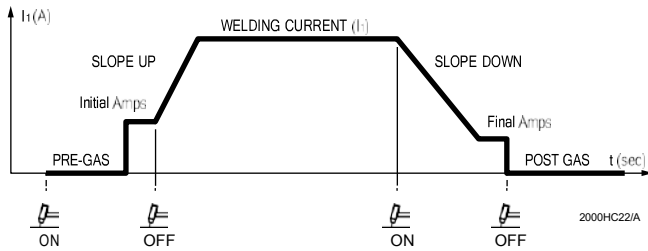

L6 CYCLE

When this function has been activated, TIG welding takes place as follows:

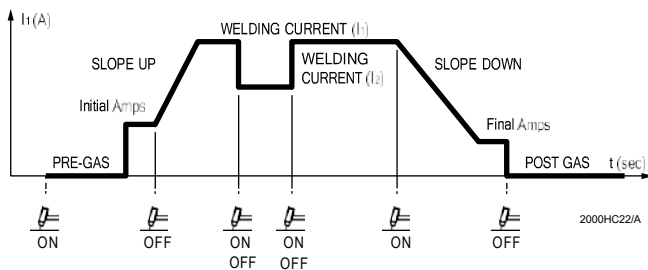

This welding mode is especially indicated for welding profiles with different thickness, where continuous current variation is required. Also, when welding aluminum, it allows you to have a higher initial current, thereby facilitating pre-heating of the workpiece.

L7 SPOT WELDING

This can be used by pushing the torch button to spot weld for a pre-set period of time (in seconds) at the end of which the arc switches off automatically.

PULSE

When using one of the 2 TIG welding processes, it makes it possible to set one of the 3 pulsation modes available on the welding machine, using the relevant button:

- L23** SYN PULSE
- L24** FAST PULSE
- L25** SLOW PULSE

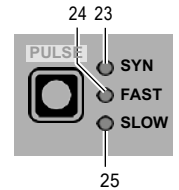

WARNING: The operator can decide to TIG weld without using any pulsation mode. If this is the case, the 3 LEDs are switched off.

WELDING PARAMETERS

Each time the button is pushed, the welding machine selects the next function according to the machine configuration, the welding process, the welding mode, etc...

MMA WELDING CONFIGURATION

When using the electrode welding process, this allows you to set up the following welding parameters, based on which LED is flashing:

- L8** HOT START
- L9** ARC FORCE
- L10** PRINCIPAL welding CURRENT I1

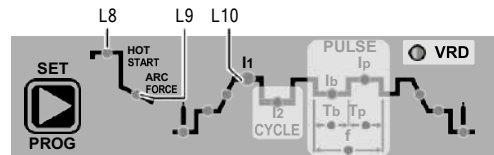

TIG WELDING CONFIGURATION

When one of the 2 TIG welding processes available on the welding machine is activated, this allows you to set up the following welding parameters, based on which LED is flashing:

- L11** PRE-GAS duration
- L12** SLOPE UP duration
- L13** BASE current duration Tb

WARNING: This can only be programmed when SLOW pulsation is activated.

- L14** PEAK current duration Tp

WARNING: This can only be programmed when SLOW pulsation is activated.

- L15** SLOPE DOWN duration

- L16** POST-GAS duration

- L17** INITIAL welding CURRENT

- L10** PRINCIPAL welding CURRENT I1

- L18** CYCLE CURRENT I2

WARNING: This can only be programmed when the CYCLE welding mode is active.

- L19** BASE CURRENT Ib

WARNING: This can only be programmed when at least one pulsation mode is activated.

L20 PEAK CURRENT I_p

WARNING: This can only be programmed when at least one pulsation mode is activated.

L21 FINAL welding CURRENT

L22 PULSATION FREQUENCY f

WARNING: NOT programmable when SLOW pulsation mode is active.

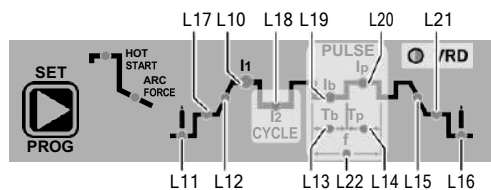

Displaying the software version installed

The POWER TIG 202 DC PULSE are fitted with a digital control with software on board defined in the factory. This software is subject to continuous evolution and improvement. The software is identified by a specific number that can be viewed on the DISPLAY (D) as follows:

- 1) With the welding machine switched on, press and hold down the **WELDING MODE** button (T1).
- 2) The DISPLAY (D) shows the type of version of software installed.
- 3) To exit, push and release the **WELDING MODE** button (T1).

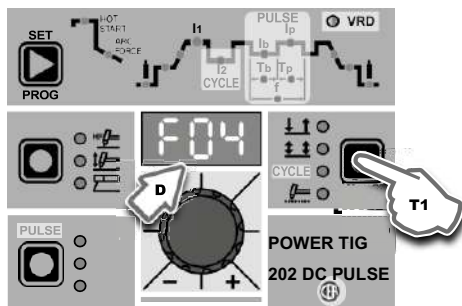

Electrode welding (MMA)

- 1) Start the welding machine by turning the power supply switch to position I.
- 2) **WELDING PROCESS SELECTION**
Push the WELDING PROCESS SELECTION key (T2) to select the ELECTRODE welding processes for welding with "HOT START" or "ARC FORCE" devices that can be programmed by the user.
- 3) Turn the ENCODER knob (E) until the DISPLAY shows the CURRENT VALUE at which you wish to weld, in relation to the diameter of the electrode you are using.

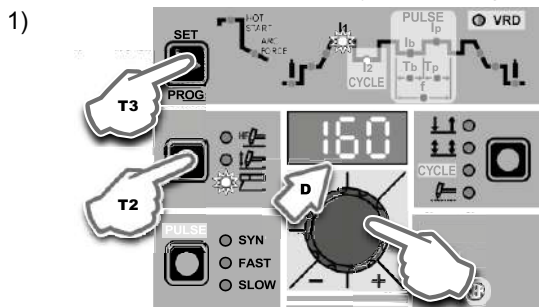

4) WELDING PARAMETERS SELECTION

To refine the weld quality, the following parameters can be set by pushing the WELDING PARAMETERS SELECTION key (T3) in succession:

- **HOT START** - This increases the welding current, in percentage terms, for a time interval that can be set at the start of the welding process, thereby reducing the risk of poor fusion at the start of the joint (L8 - HOT START - 00-100).
- **MMA ARC FORCE** - Regulates, in percentage terms, the dynamic characteristics of the arc (L9 - ARC FORCE - 00-100).
- **PRINCIPAL welding CURRENT I_1 (L10):** 5÷160 A

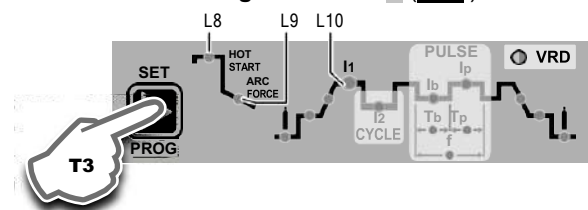

The value for the welding parameters can be regulated using the ENCODER knob (E).

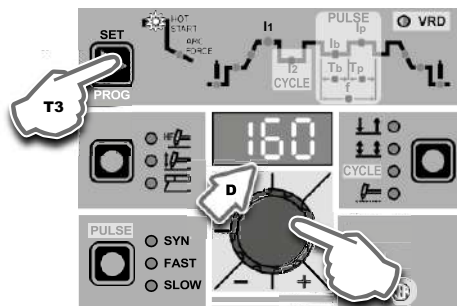

- 5) To exit these functions hold the WELDING PARAMETERS SELECTION key (T3) down for about 1 second.
- 6) Once all the selections/regulations indicated above have been made, welding can begin.
- 7) During the welding process the DISPLAY (D) shows the real Amps (A) at which the operator is actually welding.

TIG welding

Start the welding machine by turning the power supply switch to position I.

- 2) Press the WELDING PROCESS SELECTION key (T2) and select:
 - L1 a TIG "HF" welding process for direct current TIG welding with high frequency ignition.
 - L2 a TIG "Lift" welding process for direct current TIG "Lift" type welding without high frequency.

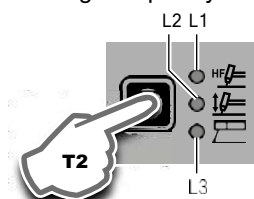

WARNING: The "Lift" ignition current is created by pushing the torch button only after having touched the workpiece with the electrode.

- 3) Press the WELDING MODE SELECTION key (T1) and go to one of the 4 options available:

- L4 2T
- L5 4T
- L6 CYCLE
- L7 SPOT WELD

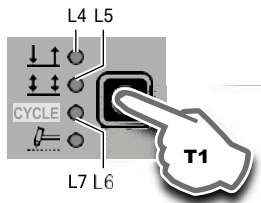

- 4) Turn the ENCODER knob (E) until the DISPLAY (D) shows the CURRENT VALUE at which you wish to weld.

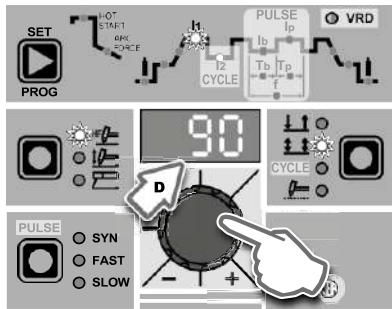

- 5) By pushing the WELDING PARAMETERS SELECTION (T3) key a number of times it is possible to set the various TIG WELDING PARAMETERS (see the "TIG Welding" paragraph - WELDING PARAMETERS).

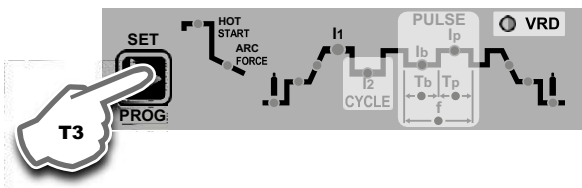

- 6) To exit welding parameter programming, hold the T3 button down for about 1 second.
- 7) Once the all the selections/regulations indicated above have been made, welding can begin.
- 8) During the welding process the DISPLAY shows the real Amps (A) at which the operator is actually welding.

TIG welding with the SPOT WELDING function on

- 1) Start the welding machine by turning the power supply switch to position I.
- 2) Press the WELDING PROCESS SELECTION key (T2) and select one of the welding machine's 2 TIG processes:
 - L1 TIG with HF ignition
 - L2 TIG with "Lift" type ignition

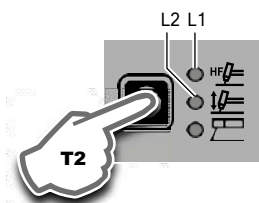

- 3) Press the WELDING MODE SELECTION key (T1) and go to one of the SPOT WELDING function.
- 4) Press and release the WELDING PARAMETERS SELECTION Key (T3) until the SPOT WELD LED starts flashing.

- 5) Rotate the ENCODER knob (E) to set the SPOT WELDING time required (0,1÷10,0 sec).

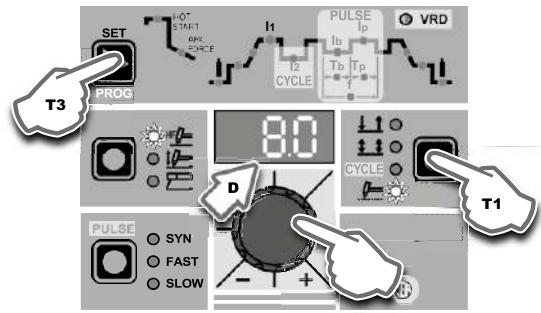

- 6) By pushing the WELDING PARAMETERS SELECTION (T3) key a number of times it is possible to set the various TIG WELDING PARAMETERS (see the "TIG Welding" paragraph - WELDING PARAMETERS).

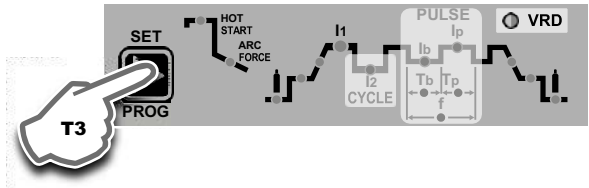

- 7) To exit welding parameter programming, hold the T3 button down for about 1 second.
- 8) Once the all the selections/regulations indicated above have been made, welding can begin.
- 9) During the welding process the DISPLAY shows the real Amps (A) at which the operator is actually welding.

TIG welding - Welding parameters

1 - "BASIC" WELDING PARAMETERS

Press the WELDING PARAMETERS SELECTION key (T3) a number of times to set:

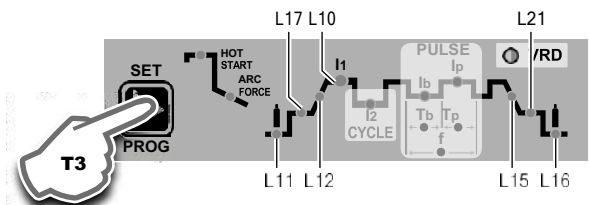

L11 PRE-GAS duration (0,05 ÷ 1,00 sec)

WARNING: This **CANNOT** be programmed when the TIG with "Lift" type ignition welding processes is active.

L17 INITIAL welding CURRENT

POWER TIG 202 DC PULSE
5 ÷ 200 A

WARNING: This can only be programmed when 4 STROKES or CYCLE welding mode is activated.

L12 SLOPE UP duration (0,0 ÷ 5,0 sec)

L10 PRINCIPAL welding CURRENT I1

POWER TIG 202 DC PULSE
5 ÷ 200 A

L15 SLOPE DOWN duration (0,0 ÷ 8,0 sec)

L21 FINAL welding CURRENT

POWER TIG 202 DC PULSE
5 ÷ 200 A

WARNING: This can only be programmed when **4 STROKES** or **CYCLE** welding mode is activated.

L16 POST GAS duration (0,5 ÷ 25,0 sec)

WARNING: When the post-gas LED flashes and the LED **I1** is on at the same time, this means that the welding machine is in the post-gas stage.

To exit the setting phase, hold the WELDING PARAMETERS SELECTION key (T3) down for about **1 second**.

2 - WELDING PARAMETERS with PULSE mode active:

Pulsed TIG welding allows greater control of the arc and better deformation of the material.

These welding machines can be used for TIG AC pulsed welding in **3** different modes:

- SLOW PULSE
- FAST PULSE
- SYN PULSE

WARNING: Pulsation is deactivated automatically for the duration of the INITIAL and FINAL current.

2A) SLOW PULSE

TIG pulse welding with manual setting of parameters. Press the PULSE key (T4) until the required pulsation is active.

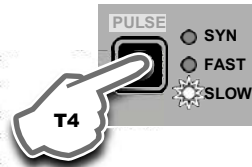

Press the WELDING PARAMETERS SELECTION key (T3) a number of times to set the following (in addition to the WELDING PARAMETERS defined as being "BASIC"):

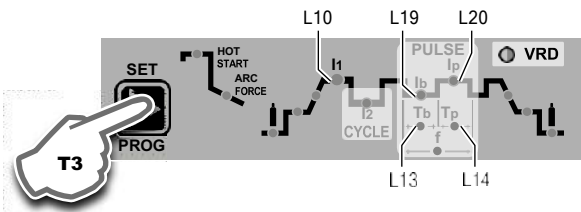

L10 L20 PEAK CURRENT Ip

POWER TIG 202 DC PULSE
10 ÷ 200 A

L10 L19 BASE CURRENT Ib

POWER TIG 202 DC PULSE
10 ÷ 200 A

L14 PEAK current duration Tp

POWER TIG 202 DC PULSE
0,01 ÷ 1,00 sec

L13 BASE current duration Tb

POWER TIG 202 DC PULSE
0,01 ÷ 1,00 sec

To exit the setting phase, hold the WELDING PARAMETERS SELECTION key (T3) down for about **1 second**.

2B) FAST PULSE

TIG pulse welding with manual setting of parameters.

Press the PULSE key (T4) until the required pulsation is active.

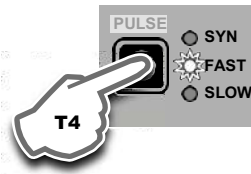

Press the WELDING PARAMETERS SELECTION key (T3) a number of times to set the following (in addition to the WELDING PARAMETERS defined as being "BASIC"):

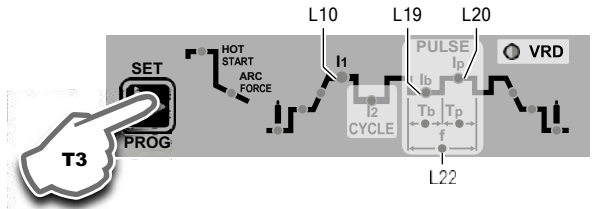

L10 L20 PEAK CURRENT Ip

POWER TIG 202 PULSE
10 ÷ 200 A

L10 L19 BASE CURRENT Ib

POWER TIG 202 PULSE
10 ÷ 200 A

L22 PULSATION FREQUENCY f

	POWER TIG 202 DC PULSE
FAST	0,5 ÷ 500 Hz

To exit the setting phase, hold the WELDING PARAMETERS SELECTION key (T3) down for about **1 second**.

2C) SYN PULSE

TIG pulse welding with synergic setting of parameters.

Press the PULSE key (T4) until the required pulsation is active.

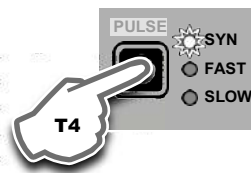

Press the WELDING PARAMETERS SELECTION key (T3) a number of times to set the following (in addition to the WELDING PARAMETERS defined as being "BASIC"):

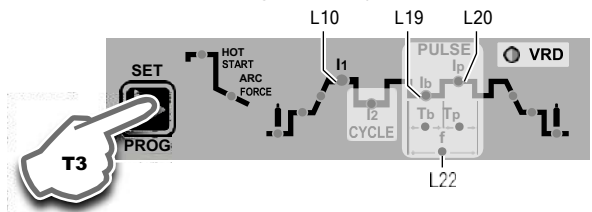

L10 - L20 PEAK CURRENT I_p

POWER TIG 202 DC PULSE
25 ÷ 200 A

This function, which is good for less skilled operators, makes it possible to change the pulsation parameter (Peak current I_p) and the other values for the corresponding pulsation parameters (Base current I_b - Pulsation frequency f) vary automatically. To exit the setting phase, hold the WELDING PARAMETERS SELECTION key (T3) down for about 1 second.

3 - WELDING PARAMETERS with PULSE mode and CYCLE welding mode active (CYCLE LED on)

When this welding mode is active it is possible to work at 2 different pulse current levels (I_1 and I_2). To do so you must also set (not only pulse parameters I_b , I_p , and f), but also the 2nd level PEAK current (I_{2p}). The other 2nd level pulse parameters (BASIC CURRENT I_{2b} and FREQUENCY f) are achieved synergically. The FREQUENCY remains constant while the 2nd level BASIC CURRENT I_{2b} is proportional to the ratio between the 1 level currents.

3A - SLOW PULSE + CYCLE

Press the PULSE key (T4) until the required pulsation is active (SLOW LED on). Press the WELDING MODE SELECTION key (T1) until the CYCLE welding mode is active (CYCLE LED on).

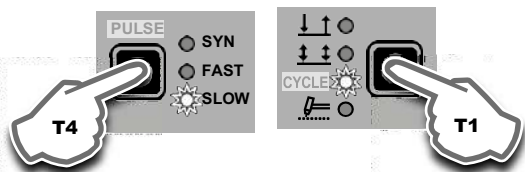

Press the WELDING PARAMETERS SELECTION key (T3) a number of times to set the following (in addition to the WELDING PARAMETERS defined as being "BASIC"):

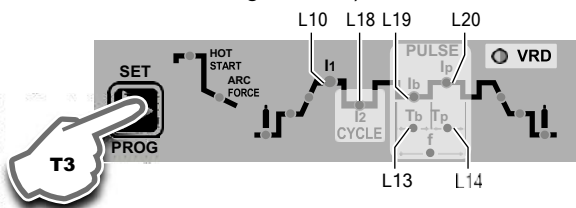

L10 L20 1st LEVEL PEAK CURRENT I_{1p}

POWER TIG 202 PULSE
10 ÷ 200 A

L18 L20 2nd LEVEL PEAK CURRENT I_{2p}

POWER TIG 202 PULSE
10 ÷ 200 A

L10 L19 1st LEVEL BASE CURRENT I_{1b}

POWER TIG 202 PULSE
10 ÷ 200 A

L14 PEAK current duration T_p

POWER TIG 202 PULSE
0,01 ÷ 1,00 sec

L13 BASE current duration T_b

POWER TIG 202 PULSE
0,01 ÷ 1,00 sec

To exit the setting phase, hold the WELDING PARAMETERS SELECTION key (T3) down for about 1 second.

3B - FAST PULSE + CYCLE

Press the PULSE key (T4) until the required pulsation is active (FAST LED on). Press the WELDING MODE SELECTION key (T1) until the CYCLE welding mode is active (CYCLE LED on).

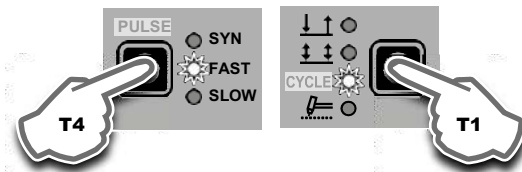

Press the WELDING PARAMETERS SELECTION Key (T3) a number of times to set the following (in addition to the WELDING PARAMETERS defined as being "BASIC"):

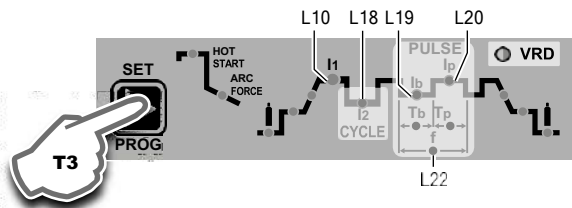

L10 L20 1st LEVEL PEAK CURRENT I_{1p}

POWER TIG 202 PULSE
10 ÷ 200 A

L18 L20 2nd LEVEL PEAK CURRENT I_{2p}

POWER TIG 202 PULSE
10 ÷ 200 A

L10 L19 1st LEVEL BASE CURRENT I_{1b}

POWER TIG 202 PULSE
10 ÷ 200 A

L22 PULSATION FREQUENCY f

POWER TIG 202 PULSE	
FAST	0,5 ÷ 500 Hz

To exit the setting phase, hold the WELDING PARAMETERS SELECTION key (T3) down for about 1 second.

3C - SYN PULSE + CYCLE

Press the PULSE key (T4) until the required pulsation is active (SYN LED on). Press the WELDING MODE SELECTION key (T1) until the CYCLE welding mode is active (CYCLE LED on).

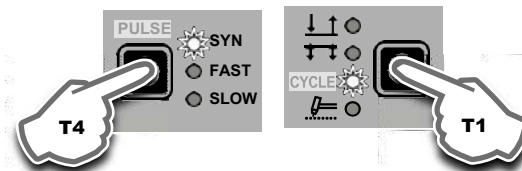

Press the WELDING PARAMETERS SELECTION key (T3) a number of times to set the following (in addition to the WELDING PARAMETERS defined as being "BASIC"):

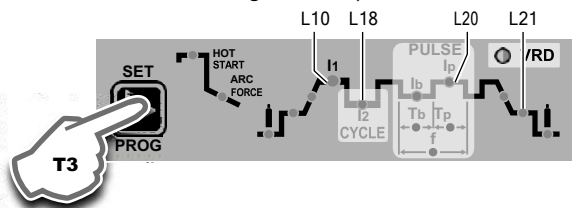

L10 - L20 1st LEVEL PEAK CURRENT I_{1p}

POWER TIG 202 PULSE
25 ÷ 200 A

WARNING: When the SYN PULSE function is active, the 1st level PEAK CURRENT (I_{1p}) is regulated to achieve a synergy with the values for the other 1st level parameters (I_{1b}, f).

L18 - L20 2nd LEVEL PEAK CURRENT I_{2p}

POWER TIG 202 PULSE
25 ÷ 200 A

WARNING: When the SYN PULSE function is active, the 2nd level PEAK CURRENT (I_{2p}) is regulated to achieve a synergy with the values for the other 2nd level parameters (I_{2b}, f).

If you want to do a test weld, during the test the LED for the parameter selected flashes and the DISPLAY shows the value for the parameter you are setting.

To exit the setting phase, hold the WELDING PARAMETERS SELECTION key (T3) down for about **1 second**.

NOTE: During the welding process if LED I₁ and LED I_p stay switched on on the DISPLAY, the 1st level current at which you are welding is displayed.

NOTE: During the welding process if LED I₂ and LED I_p stay switched on on the DISPLAY, the 2nd level current at which you are welding is displayed.

Creating and memorising automatic welding points

The welding machine has scope for saving up to 99 WELDING PROGRAMS broken down into two categories:

- F + 01÷99 = Free, non-saved programs.
- P + 01÷99 = Saved programs.

Once you have defined the parameters the operator requires to do their work properly, you can save them in the memory and create a WELDING PROGRAM by proceeding as follows.

WARNING: To access the setting saving phase, the PRINCIPAL CURRENT LED I₁ must be switched on without flashing.

- 1) Hold the SET/PRG key (T3) down for at least **3** consecutive seconds until the DISPLAY (D) reads **F**, accompanied by a flashing number (e.g. F01).

In order to be able to choose WELDING PROGRAM **F** that is free, simply rotate the ENCODER knob (E).

It is also possible to overwrite a program **P** already saved.

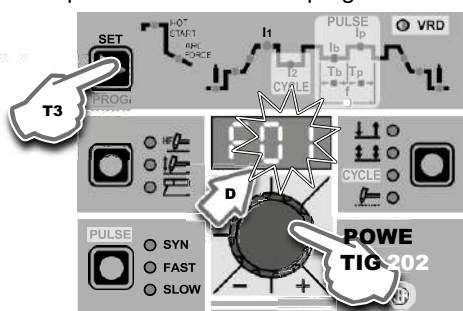

- 2) To **SAVE** the PROGRAM hold the SET/PRG key (T3) down until the DISPLAY reads "**Stop**".

- 3) The WELDING PROGRAM has now been saved and its number appears in the DISPLAY (D) along with the other settings saved (corresponding LEDs on without flashing). The letter **F** (free program, for example: F01) will be replaced by the letter **P** (saved program, for example: P01).

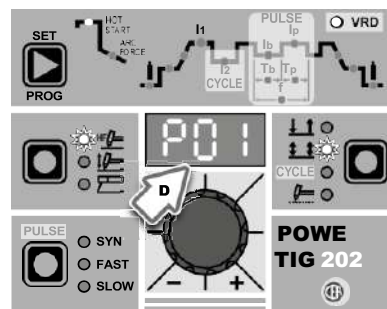
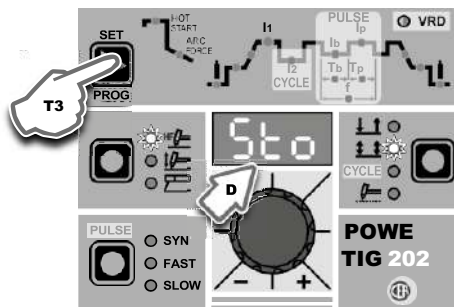

PROGRAMMED and/or MANUAL welding

PROGRAMMED WELDING

When the WELDING PROGRAM has been saved, the operator can weld using only pre-set values as they cannot edit any type of parameter / function. To edit, switch to MANUAL welding mode.

MANUAL WELDING

To go back to set / edit the parameters selected or to create a new program, proceed as follows:

- 1) Hold the SET/PRG key (T3) down (about **3** seconds) until the DISPLAY (D) shows the number of the program selected flashing (e.g. F06).

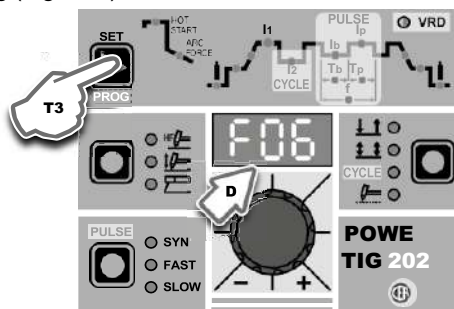

- 2) Turn the ENCODER (E) knob until the DISPLAY (D) reads **MAN**.



- 3) Press and release the SET/PRG key (T3) and the machine goes back to the initial operation condition.
- 4) You can now set or edit the individual parameters or create new programs.
- 5) Rotate the ENCODER Knob (E) to scroll the programs until you find an empty, unused program slot.

Calling up saved programs

- 1) Hold the SET/PRG key (T3) down (about **3 seconds**) until the DISPLAY (D) shows the number of the program selected flashing (e.g. **F06**).
- 2) Turn the ENCODER knob (E) until the DISPLAY (D) shows the program number (flashing) you wish to call up (e.g. **P05**).

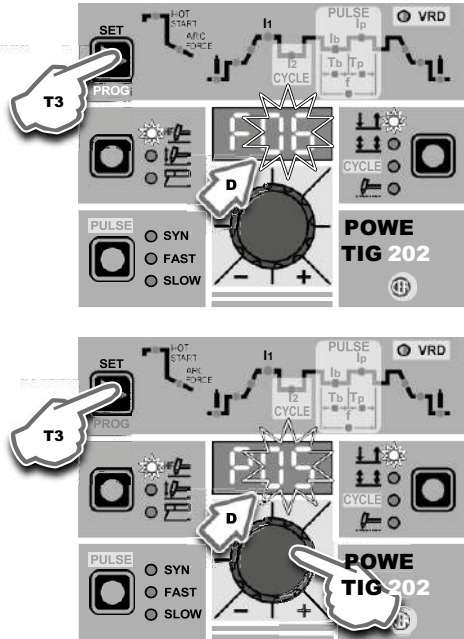

NOTE: The saved programs are those that begin with the letter **P**, whereas the free programs available are those that begin with the letter **F**.

- 3) Press and release the SET/PRG key (T3) to call up the program number selected.
- 4) You can now carry out **PROGRAMMED** welding.

Viewing the parameters set

- 1) Call up the program required (see the “Calling up saved programs” paragraph).
- 2) Press and release the WELDING PARAMETERS SELECTION key (T3) to view the parameters set in sequence.
- 3) Hold the WELDING PARAMETERS SELECTION key (T3) down for more than **1 second** to go back to the program selected.

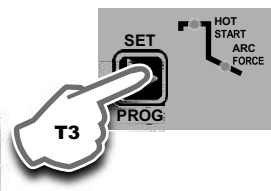

NOTE: If the parameters set are edited, you automatically exit programming.

Activating the VRD device

To activate the VRD device, which must be done when the welding machine is switched off:

- 1) Use a suitable screwdriver to unscrew the 4 screws that fix the control panel to the welding machine.
- 2) Position JUMPER W1 on the DIGITAL INTERFACE BOARD in the correct position, following the instructions given in Figure A.
- 3) Use a suitable screwdriver to tighten the 4 screws that fix the control panel to the welding machine.
- 4) Start the welding machine by pushing the switch on the rear panel to position **I**.

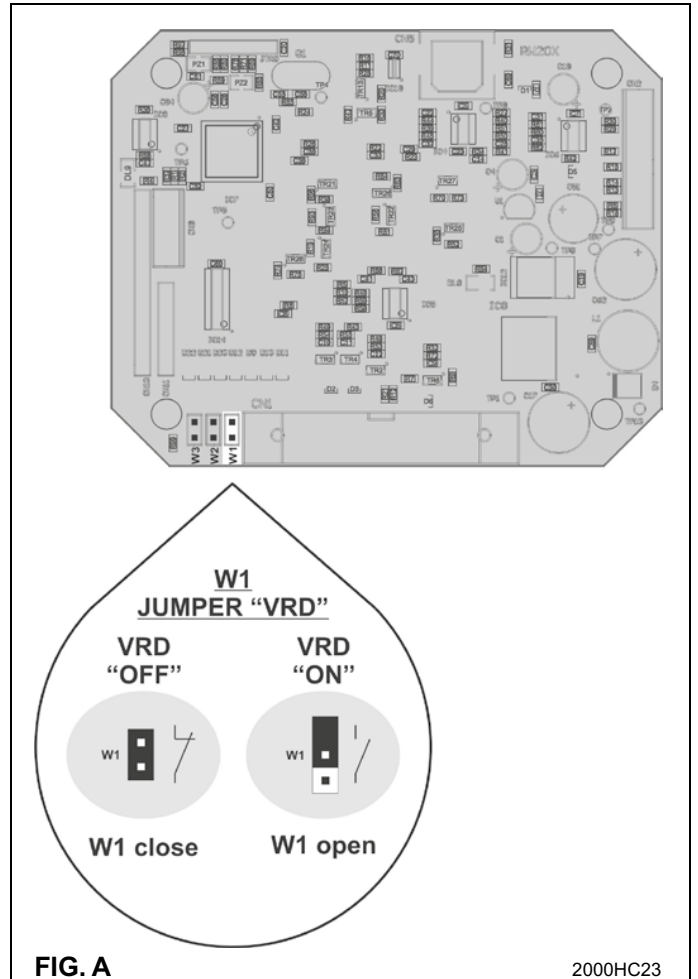

FIG. A

2000HC23

When the control panel switches on the VRD LED will come on and will be **GREEN**, which means that the VRD function is on.

To “deactivate” the VRD device and therefore start to weld, follow this simple procedure: First touch the workpiece with the electrode, then detach it and ignite the arc within a **MAX** of **0,3 seconds**, otherwise if this time is exceeded the VRD device starts and prevents welding.

During welding the VRD LED turns **RED**, which does not indicate any malfunction on the welding machine, but that the VRD device has been deactivated to allow welding.

Auxiliary functions

“Energy saving”

This function manages correct functioning of the cooling fan and cooling equipment that only run when strictly necessary, that is:

- **FAN MOTOR** - The fan is activated when:
 - During welding or for a certain period of time after this is finished.
 - When the thermostat intervenes or for a certain period of time after it has just been reset.

Factory default

WARNING: This operation results in complete resetting of all parameters to the factory settings.

To reset the settings, you must:

- With the machine switched on, push and hold down the WELDING MODE (T1) and SELECT WELDING PROCESS (T2) buttons simultaneously for about 3 seconds.
- When all the LEDs switch on at the same time, reinstatement of the welding machine’s software to its default settings is complete.
- The message on the DISPLAY (D) reads 80.
- The reset procedure has now been completed successfully.

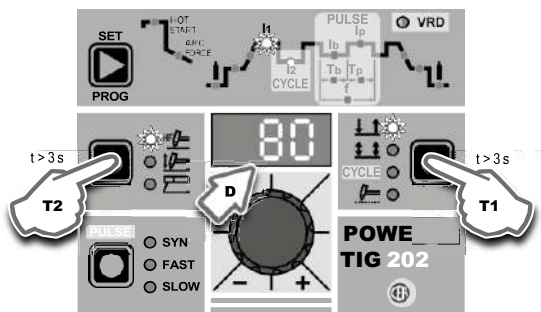

Error and protection conditions

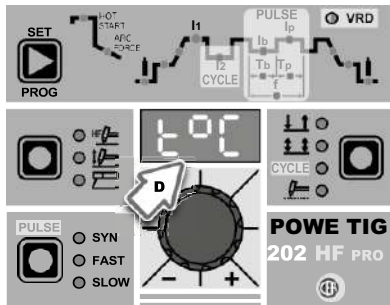

The equipment is protected against problems and if any arise the DISPLAY shows fixed or flashing (error code) messages (depending on the type of error) that serve to inform the operator that a fault has occurred in the equipment (see table 1).

The table provides a summary of all the error conditions that may arise on the equipment and, if possible, what the operator must do to attempt to resolve the problem.

Automatic reset error: once the alarm condition has been resolved the equipment starts working again and the operator can weld again!

PLEASE NOTE: If the fault persists look for the cause of the fault and contact our technical assistance department if necessary.

All of this is necessary to allow our technical assistance department (which must be contacted each time error messages appear on the equipment’s operator interface) to resolve problems more easily, as quickly as possible and thanks to the user’s reports, also because, in the meantime the machine will not allow the operator to do their work.

Table 1

Display	Diagnosis
E0.0	POWER SUPPLY FAILURE NON automatic reset error. This error can only arise when switching on and not when the welding plant is working normally.
E1.0	USER FILE MISSING NON automatic reset error. Immediately contact technical assistance dept.
E1.1	CONFIGURATION FILE MISSING NON automatic reset error. Immediately contact technical assistance dept.
E1.2	INTERNAL MEMORY ERROR NON automatic reset error. Immediately contact technical assistance dept.
E1.3	CALIBRATION FILE MISSING NON automatic reset error. Immediately contact technical assistance dept.
t°C	THERMAL PROTECTION The welding stops due to an excessively high temperature (thermostat activated). Automatic reset error.

WARNING: The welding machine has a built-in electronic protective device to deal with fluctuations in mains voltage that switches the machine off automatically (voltage exceeding 300 V), without indicating any type of error or warning message for the operator. Subsequently it starts functioning again automatically when the voltage has dropped to below the value indicated above.

Power TIG Series



GeKaMac[®]



Gedik Welding Inc.

Ankara Caddesi No: 306 Şeyhli 34906 Pendik - İstanbul / Turkey

P. +90 216 378 50 00 • F. +90 216 378 20 44

www.gedikwelding.com